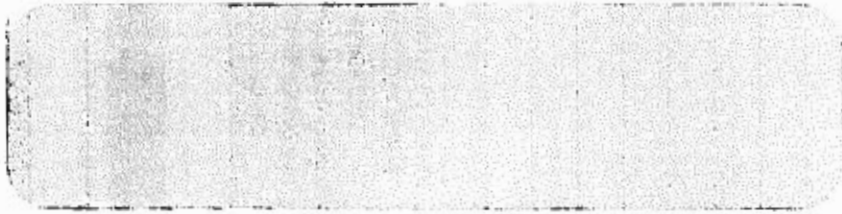

Exhibit B:
Envelope Examples
for IFB No. 22006

DHS-APPEALS OFFICE
P.O. BOX 339
HONOLULU, HAWAII 96809-0339

Return Service Requested



Important Notice from DHS, Please Read.
Importante nga Paka-ammo ti DHS, Panga-asiyo ta basaenyo.
Auchean esinesin seni DHS kose mochen aneani.
Kojela Aurok jen DHS, Jouij im Riiti.
DHS (후생국) 에서의 중요한 공지 사항, 꼭 읽으세요.
請閱讀, DHS 重要通知。
Thông Báo Quan Trọng từ DHS, Xin Vui Lòng Đọc.

DEPARTMENT OF HUMAN SERVICES
Audit, Quality Control, and Research Office/QC-Hilo
75 Aupuni Street, Room 111
Hilo, Hawaii 96720

Return Service Requested

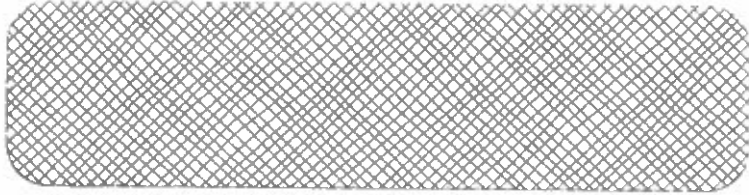

DEPARTMENT OF HUMAN SERVICES
Audit, Quality Control, and Research Office/QC-Maui
54 High Street, Room 125
Wailuku, Hawaii 96793

Return Service Requested

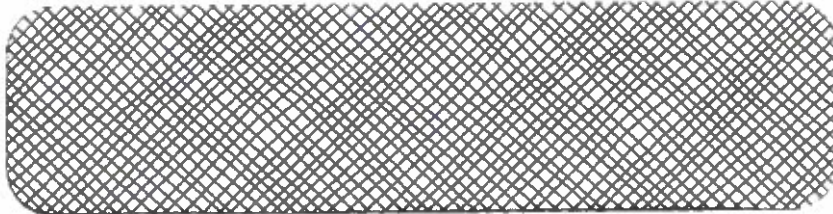

DEPARTMENT OF HUMAN SERVICES
Audit, Quality Control, and Research Office/QC
P.O. Box 339
Honolulu, Hawaii 96809-0339

Return Service Requested

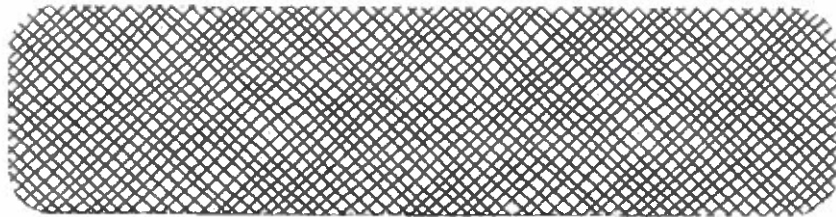

DHS/Hoopono Item A. No return address.

DHS: FMO/Accounting/CRS
Envelope #A

DHS – FMO/ACCTG/CRS
P.O. BOX 4147
HONOLULU, HAWAII 96812-4147

RETURN SERVICE REQUESTED



DHS: FMO/Accounting/CRS
Envelope #G



RETURN SERVICE REQUESTED



KRAFT

F - DHS - FMO - Maureen - Face

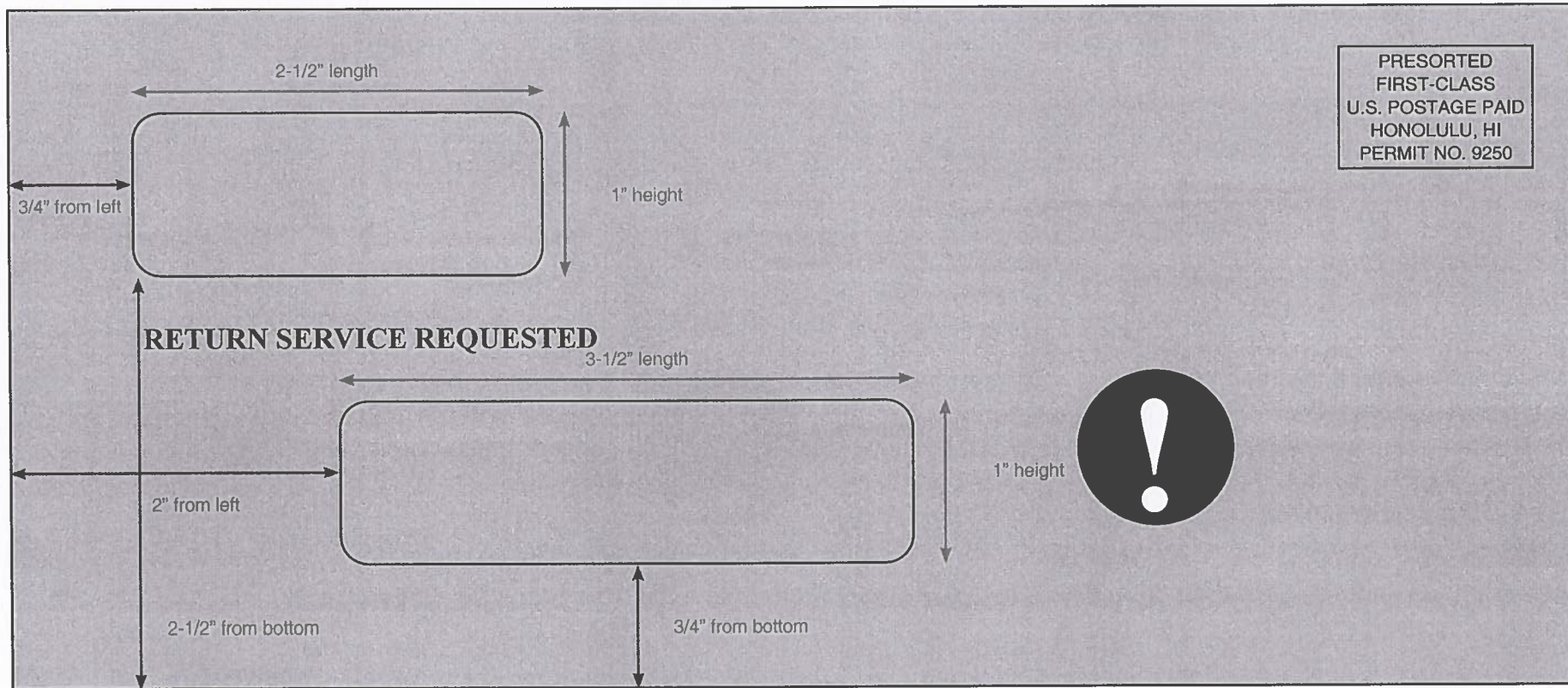

"F"



Important Notice from DHS, Please Read.
Importante nga Paka-ammo ti DHS, Panga-asiyo ta basaenyo.
Auchean esinesin seni DHS kose mochen aneani.
Kojela Aurok jen DHS, Jouij im Riiti.

DHS (후생국) 에서의 중요한 공지 사항, 꼭 읽으세요.
請閱讀 DHS 重要通知。

Thông Báo Quan Trọng từ DHS, Xin Vui Lòng Đọc.

White

G - DHS - FMO - Maureen - Face

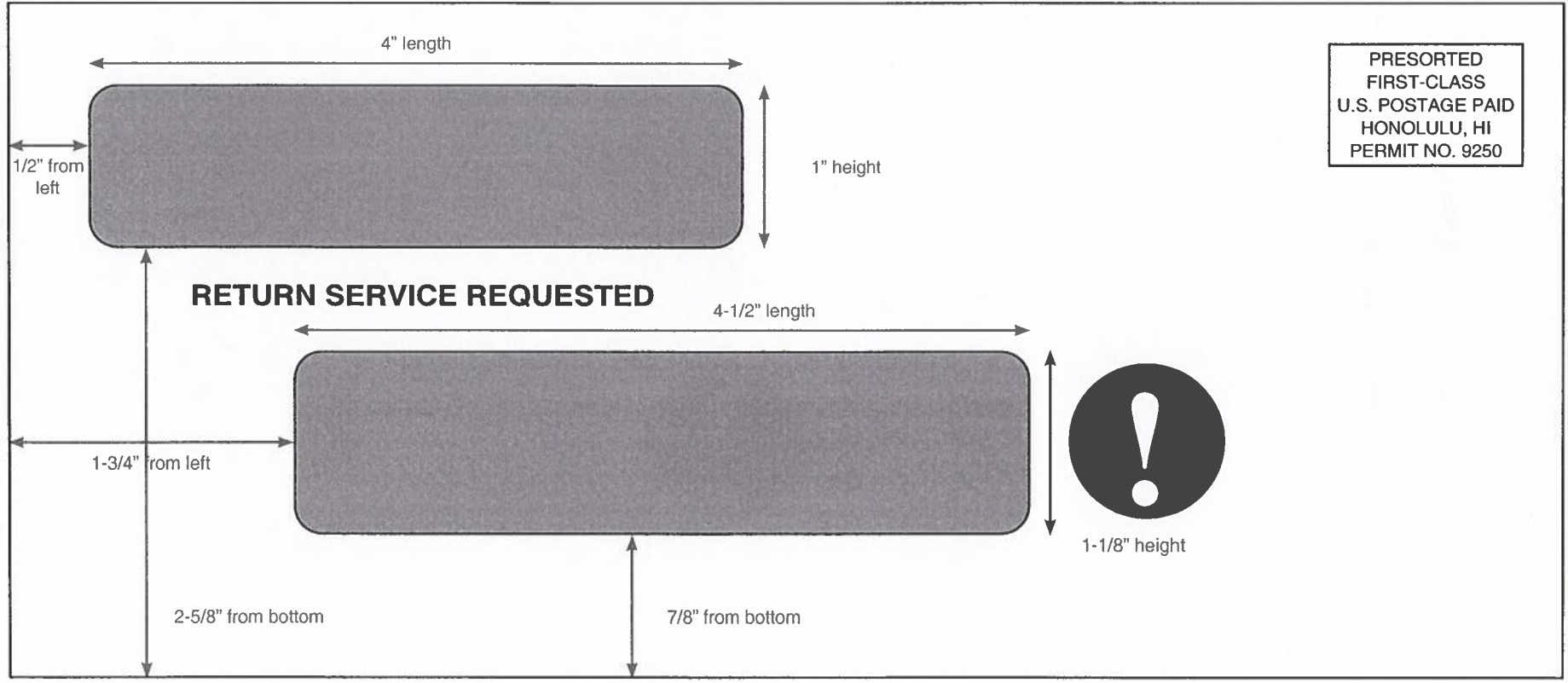

"G"



Important Notice from DHS, Please Read.
Importante nga Paka-ammo ti DHS, Panga-asiyo ta basaenyo.
Auchean esinesin seni DHS kose mochen aneani.
Kojela Aurok jen DHS, Jouij im Riiti.
DHS (후생국) 에서의 중요한 공지 사항, 꼭 읽으세요.
請閱讀 DHS 重要通知。
Thông Báo Quan Trọng từ DHS, Xin Vui Lòng Đọc.

DHS/SSD/APCSB/
SCPO. Item B.

B - DHS - SSD - Feliza

Request Item B with return address shown.

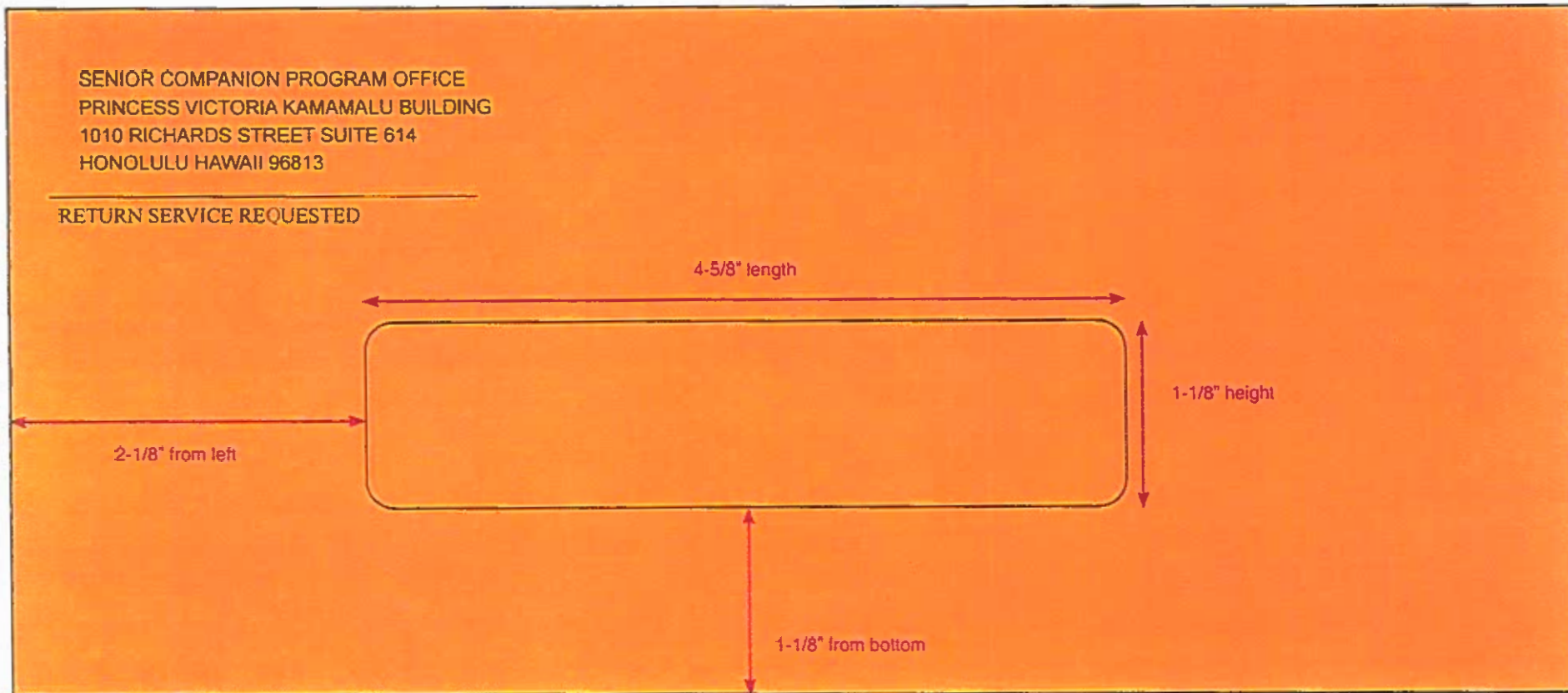

Social Services: Item B. Foster Grandparent Program

AFTER 10 DAYS RETURN TO
Department of Human Services
FOSTER GRANDPARENT PROGRAM OFFICE
1010 Richards Street, Suite 614
Honolulu, HI 96813

Foster Grandparent Program - Sample

AFTER 10 DAYS RETURN TO
Department of Human Services
FOSTER GRANDPARENT PROGRAM OFFICE
1010 Richards Street, Suite 614
Honolulu, HI 96813

Foster Grandparent Program - Sample

OCWSS2: No return address requested. Office will apply return address themselves.

Envelopes standard #10, 4-1/8" x 9-1/2"

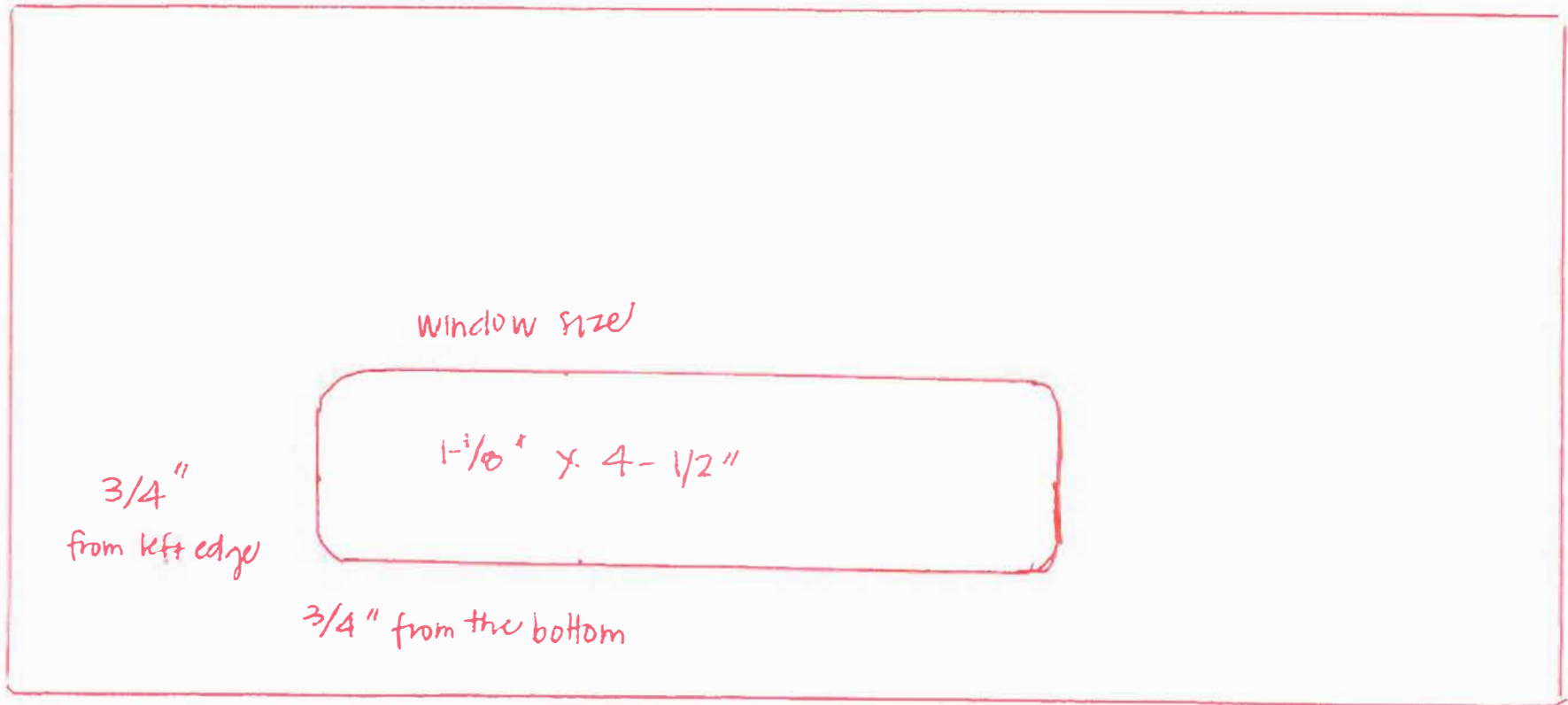

OCWSS2: No return address requested. Office will apply return address themselves.

Envelopes standard #10, 4-1/8" x 9-1/2"

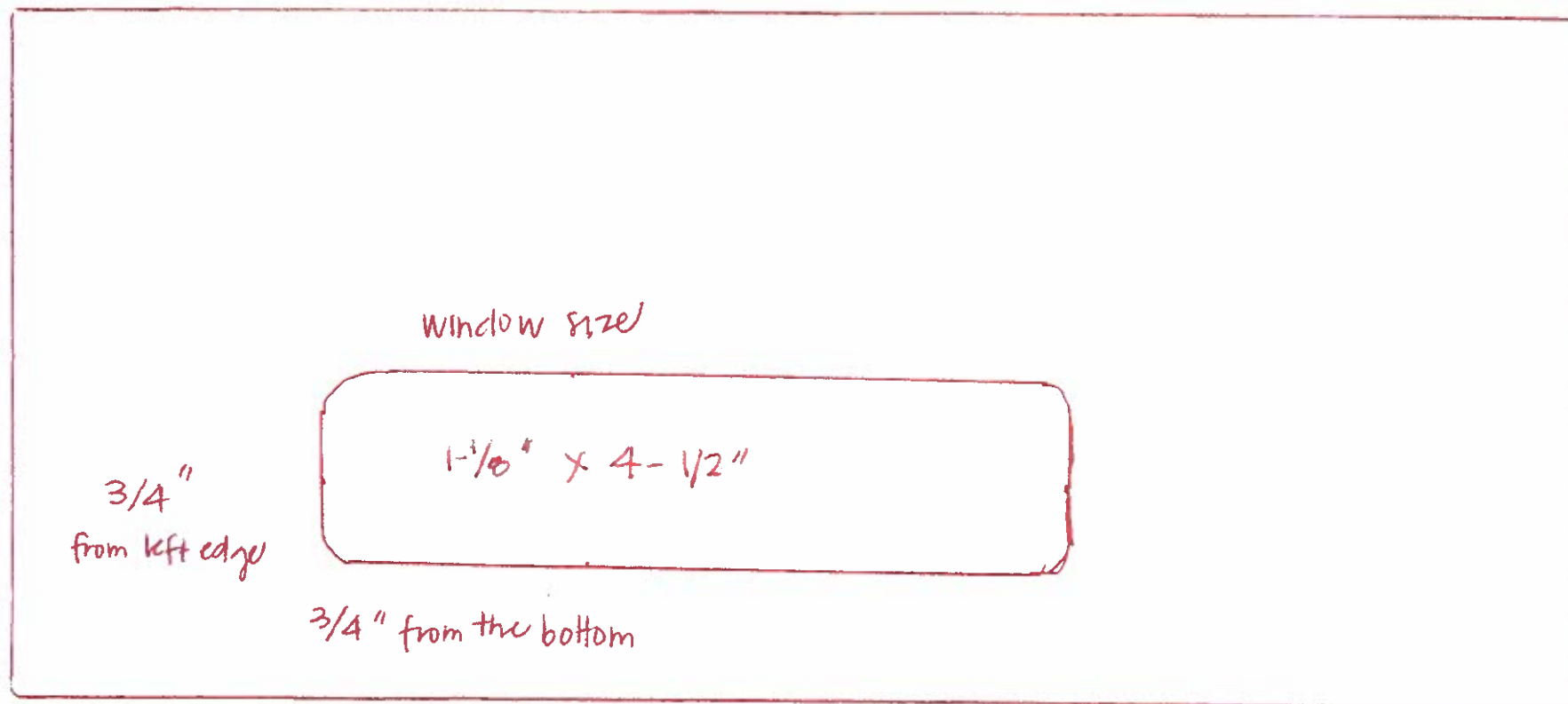

State of Hawaii
DIVISION OF VOCATIONAL REHABILITATION
Kuakini Tower
75-5722 Kuakini Hwy., Suite 213
Kailua-Kona, HI 96740



Important Notice from DVR, Please Read.
Importante nga Paka-ammo ti DVR, Panga-asiyo ta basaenyo.
Auchean esinəsin seni DVR kose mochen aneani.
Kojela Aurok jen DVR, Jouij im Riiti.
DVR (후생국) 에서의 중요한 공지 사항, 꼭 읽으세요.
請閱讀, DVR 重要通知。
Thông Báo Quan Trọng từ DVR, Xin Vui Lòng Đọc.



DEPARTMENT OF BUSINESS, ECONOMIC DEVELOPMENT & TOURISM

FOREIGN-TRADE ZONE NO. 9

521 ALA MOANA BLVD., #101
HONOLULU, HAWAII 96813

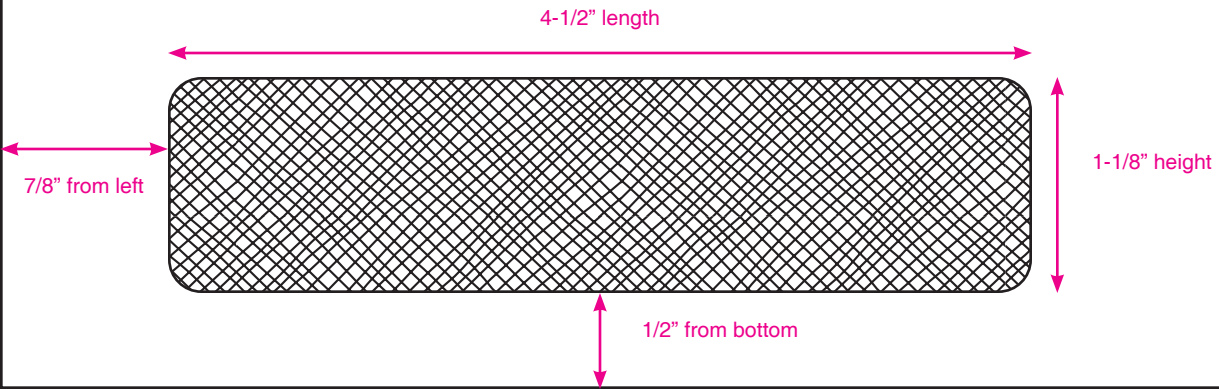

4



DEPARTMENT OF BUSINESS, ECONOMIC DEVELOPMENT & TOURISM

FOREIGN-TRADE ZONE NO. 9
521 ALA MOANA BLVD., #101
HONOLULU, HAWAII 96813

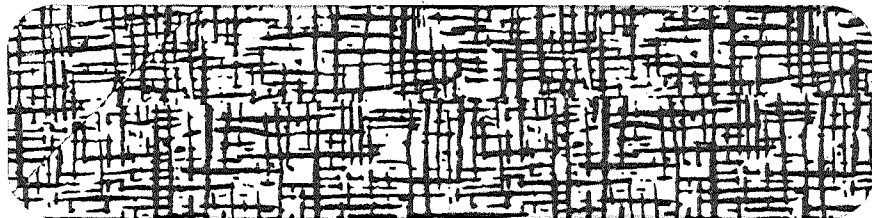



DISTRICT COURT OF THE FIRST CIRCUIT
'EWA-PEARL CITY DIVISION
THE JUDICIARY • STATE OF HAWAII
870 Fourth Street
Pearl City, Hawai'i 96782-3398

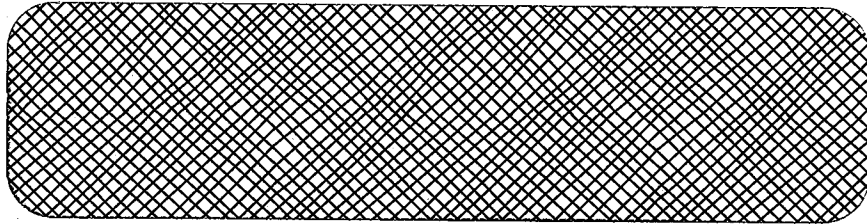



DISTRICT COURT OF THE FIRST CIRCUIT
THE JUDICIARY • STATE OF HAWAII
EWA DISTRICT COURT
870 Fourth Street
Pearl City, Hawai'i 96782-3398

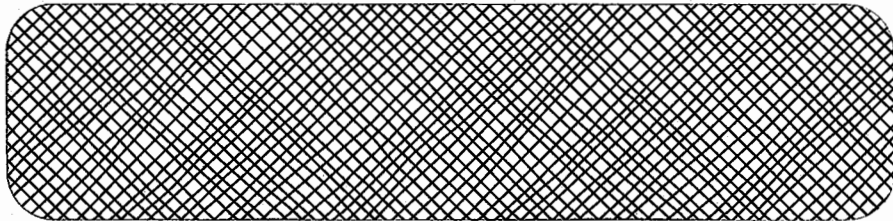



DISTRICT COURT OF THE FIRST CIRCUIT
THE JUDICIARY • STATE OF HAWAI'I
WAI'ANAЕ DIVISION
4675 Kapolei Parkway
Kapolei, Hawai'i 96707

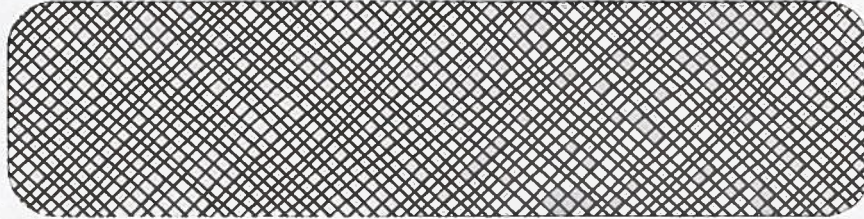

DISTRICT COURT OF THE FIRST CIRCUIT
THE JUDICIARY • STATE OF HAWAI'I
WAI'ANAЕ DIVISION
4675 Kapolei Parkway
Kapolei, Hawai'i 96707

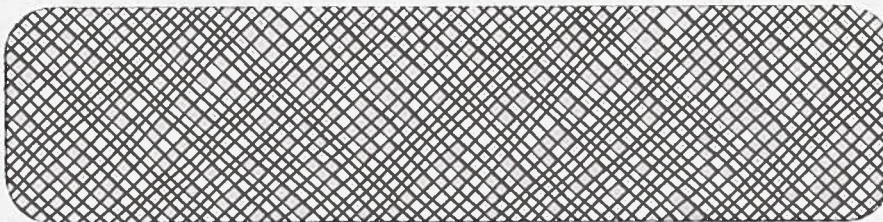
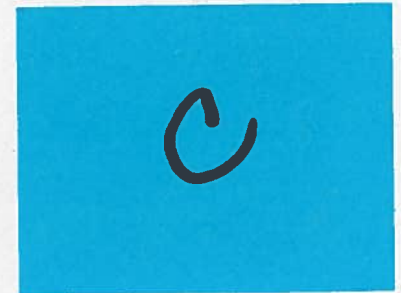



FIRST CIRCUIT • COURT OPERATIONS
RURAL COURTS • KĀNE'OHE DIVISION
THE JUDICIARY • STATE OF HAWAII
45-939 Po'okela Street
Kāne'ōhe, Hawai'i 96744-5725

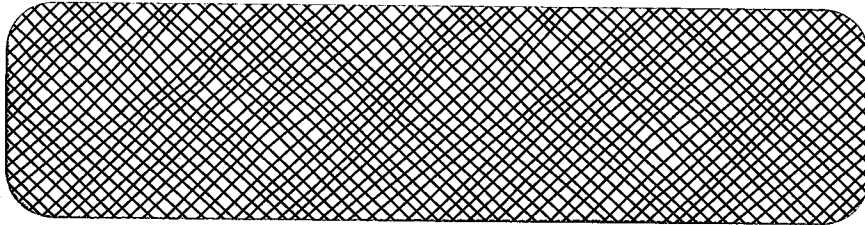



DISTRICT COURT OF THE FIRST CIRCUIT
WAHIAWĀ-WAIALUA DIVISION
THE JUDICIARY • STATE OF HAWAII
1034 Kilani Avenue, Suite 110
Wahiawā, Hawai'i 96786-2274

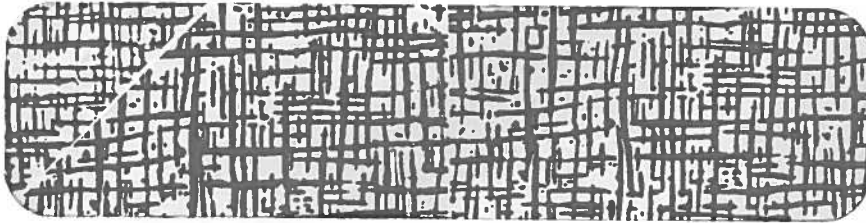

DISTRICT COURT OF THE FIRST CIRCUIT
WAHIAWĀ-WAIALUA DIVISION
THE JUDICIARY • STATE OF HAWAII
1034 Kilani Avenue, Suite 110
Wahiawā, Hawai'i 96786-2274



Requirements- 2024, 2025



DISTRICT COURT OF THE FIRST CIRCUIT
ADULT/JUVENILE COMMUNITY SERVICE & RESTITUTION UNIT
THE JUDICIARY • STATE OF HAWAII
Kauikaouli Hale • 1111 Alakea Street, 3rd Floor
Honolulu, Hawaii 96813

AJCSRU
A



DISTRICT COURT OF THE FIRST CIRCUIT
ADULT CLIENT SERVICES BRANCH
THE JUDICIARY • STATE OF HAWAII
1111 Alakea Street, 2nd Floor
Honolulu, Hawaii 96813-2897

DC Probation
A

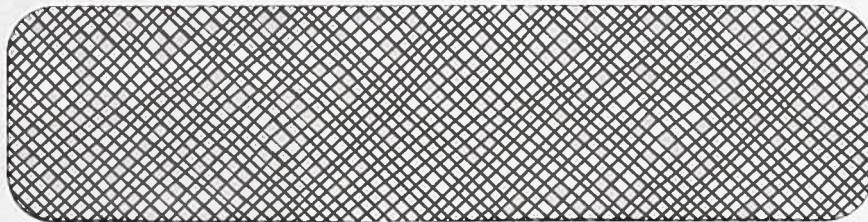



DISTRICT COURT OF THE FIRST CIRCUIT
COURT OPERATIONS • TRAFFIC VIOLATIONS BUREAU
THE JUDICIARY • STATE OF HAWAII
1111 Alakea Street, Second Floor
Honolulu, Hawaii'i 96813-2897

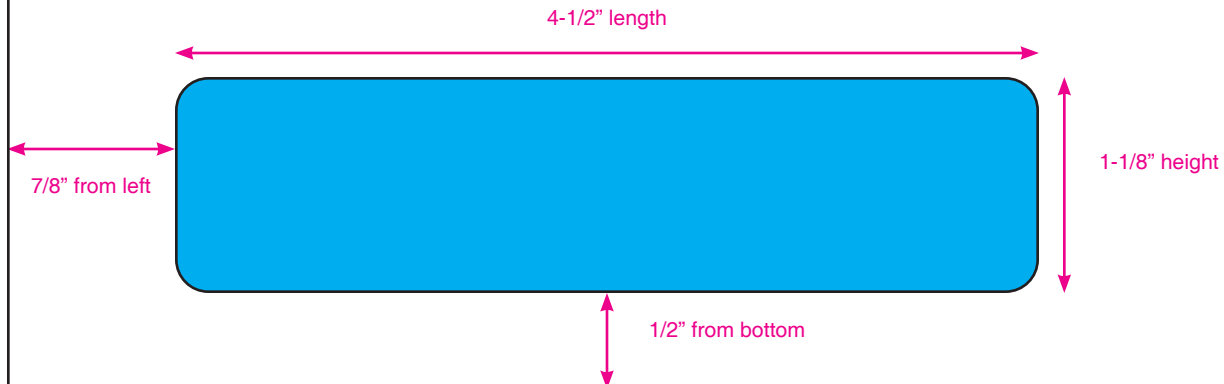



DISTRICT COURT OF THE FIRST CIRCUIT

THE JUDICIARY • STATE OF HAWAII

FISCAL / ACCOUNTING SECTION

1111 Alakea Street, 4th Floor

Honolulu, Hawaii 96813

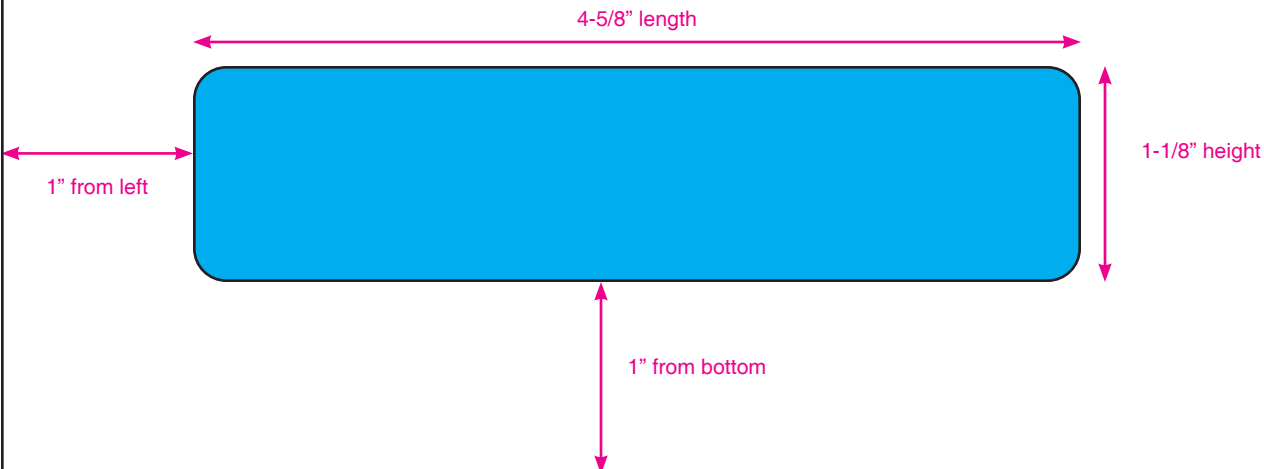



DISTRICT COURT OF THE FIRST CIRCUIT
THE JUDICIARY • STATE OF HAWAII
Fiscal Management & Support Services
1111 Alakea Street, 4th Floor
Honolulu, Hawai'i 96813

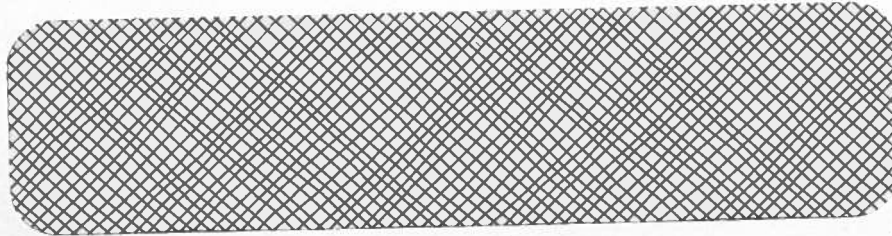

Requirements- 2023, 2024, 2025

STATE OF HAWAII
HAWAII PAROLING AUTHORITY
1177 ALAKEA STREET, GROUND FLOOR
HONOLULU, HAWAII 96813

CONFIDENTIAL

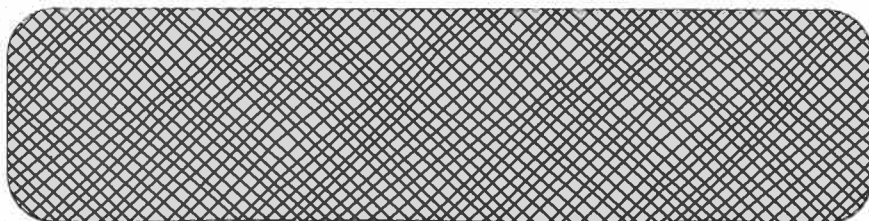

Requirements- 2023, 2024, 2025